

BRICKS

best practice guide

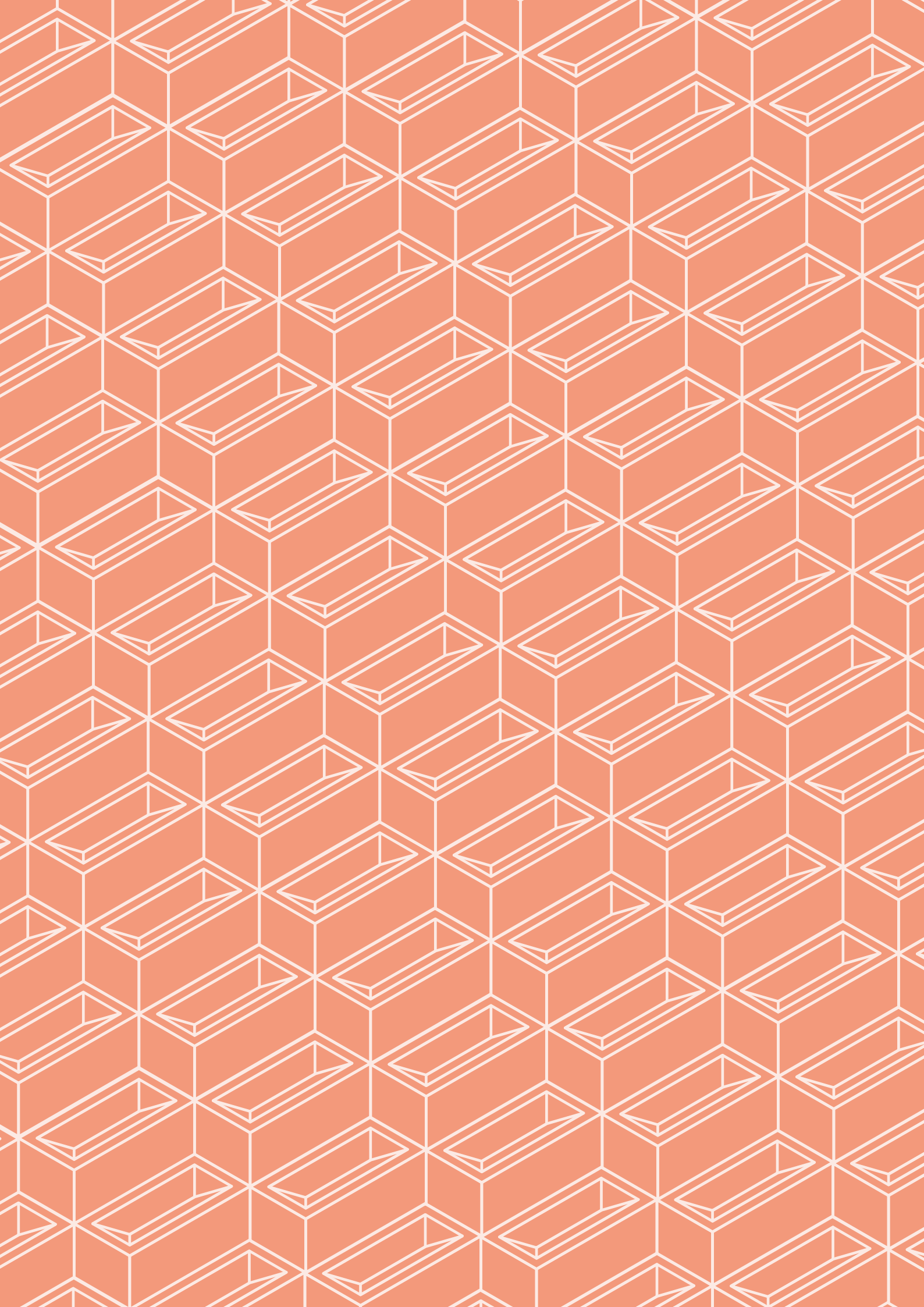

contents

1	purpose of the guide	4-5
2	brickwork in melton	6-9
3	historic brick production / historic legislation / historic dimensions	10-18
4	brick bonding / brick anatomy / brick construction	19-21
5	brick revivals: tudor / georgian / victorian / edwardian / inter-war	22-27
6	best practice: bricks in historic buildings / bricks in new buildings within historic setting	28-39
7	glossary	40-42
8	image credits	43-44

1 purpose of the guide

Relatively strong, yet small and easy to handle, fired clay brick is arguably one of the most versatile and durable of all building materials. This guide explores the wide range of its shapes, sizes, colours, textures and physical properties.

If you are referring to this document to assist in the extension of a historic building, or a new development within the historic environment, then the final chapter is the most useful to help you find the right bricks for your project - but the preceding chapters are essential points of reference to help you in this complicated process.

The technical aspects of brick repair and refurbishment are not addressed in this guide, and they must be treated as separate conservation practice.

Brick is beautiful.

September 2017

All the images presented in this guide are the author's own or they have been offered under a Creative Commons licence.

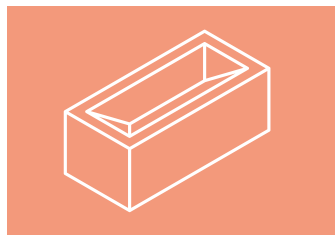
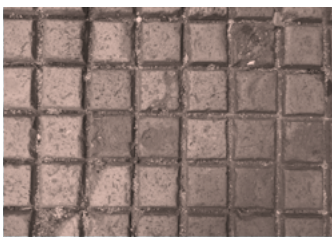
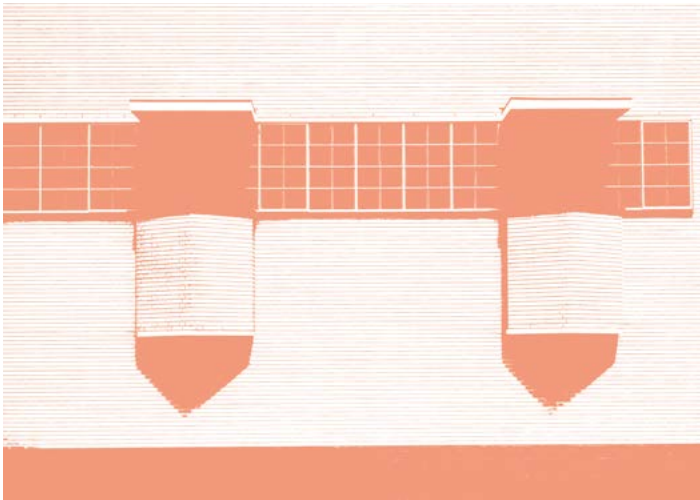

2 brickwork in melton



- A decorative brick wall forming the boundary of Burley Cottage, a Grade II listed 18th Century building in Somerby, Borough of Melton
- ▲ The same decorative brick wall beside the road leading to Burley Cottage

'Brick clay' is the term used to describe clay and shale used in the manufacture of bricks. The suitability of a clay for the manufacture of bricks depends principally on its behaviour during shaping, drying and firing. This will dictate the properties of the fired brick, such as strength and frost resistance, and most importantly its architectural appearance.

Today, most facing bricks (external bricks that can be seen on the 'face' of a building), engineering bricks and related clay-based building products are manufactured in large automated factories. The facing bricks that can be seen today on new buildings could have been manufactured many miles away.

This has not always been the case; until the mid-nineteenth century, before the advent of the railways, many buildings were constructed in the 'vernacular' tradition (using materials sourced locally). Only higher status buildings used imported materials from afar because of the high costs involved. This meant that for many brick buildings, the type of clay available in the locality determined the quality and appearance of brickwork used in construction.

"The suitability of a clay for the manufacture of bricks depends principally on its behaviour during shaping, drying and firing."





▲ Eastwell Hall on the Belvoir Estate, awaiting restoration. A Grade II* listed building built in the distinctive ironstone found throughout the Borough of Melton

The type of brick clay available locally is determined by the underlying geology of the area. The Borough of Melton is home to a wide range of geological formations below ground, most predominantly Jurassic and Triassic Lias Clays, Marlstone, Ironstone and Oolitic limestone.

While the distinctive warm, ochre-orange coloured ironstone is a common material used in many of Melton's vernacular buildings, it is the Jurassic and Triassic Lias clay deposits found below ground that have been used for the brickwork in many of Melton's historic buildings.

The principle clay deposits are part of the Mercian Mudstone Group which contains small amounts of carbonate minerals that produce bricks with a distinctive fired colour, ranging from a light pink to a deep red.

A revised 'Landscape Character Assessment' of Melton was carried out in 2011. This provides a detailed insight into the geology and materials that are found below ground for every Parish in the Borough. It can be found here:

www.melton.gov.uk/downloads/download/833/melton_landscape_character_assessment_update_2011

"The type of brick clay available locally is determined by the underlying geology of the area."



▼ A C19 imperial brick from Lion Brickworks, one of the largest brick manufacturers in the Borough, who were located north of Scalford on Eastwell Road. The company opened in 1875 and stopped making bricks in the 1930s. It is still possible to see crumbling remains of the updraught brick kilns among the derelict ruins of the site.

2c. historic dimensions

It is remarkable that bricks have remained similar in size from C13 to the present day. Dimensions have ranged between 2 - 2.5" thick / 8.5" - 9' length / 4 - 4.5" width.

A golden rule has always determined the dimension of a brick: it must be small enough for a bricklayer to hold in the hand! The most perceptible difference in historic brickwork is the thickness of the bricks, they steadily increased in size until the 20th century.

The Victorian 'Imperial brick' had a thickness of over 3". The metric brick, introduced in 1969, was smaller, measuring 215 x 102.5 x 65.0mm, a similar thickness to bricks manufactured in the C18. (Photo of difference between tudor / c18 / c19 / c20 brick)

This chart is not a definitive chronology of brick sizes, and there will always be exceptions to the rule, but the small changes in dimensions over time tell an interesting story and they can help relate to the brickwork of a historic building.

1450-1500

Length 9.5
Height 2.00/2.25



1500-1700

Length 9
Height 2.25/2.5



1784-1918

Length 9
Height 3/3.25

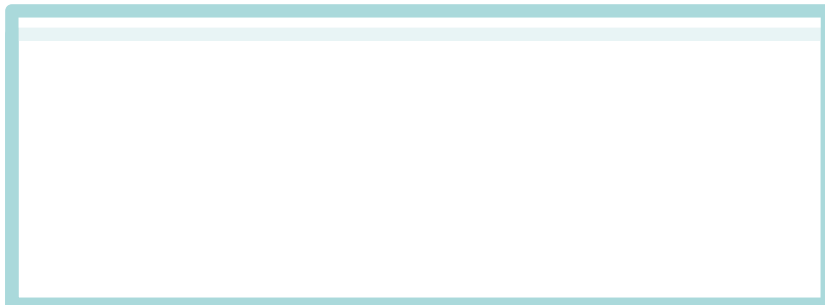

1918-Present

Length 8.5
Height 2.5/2.75

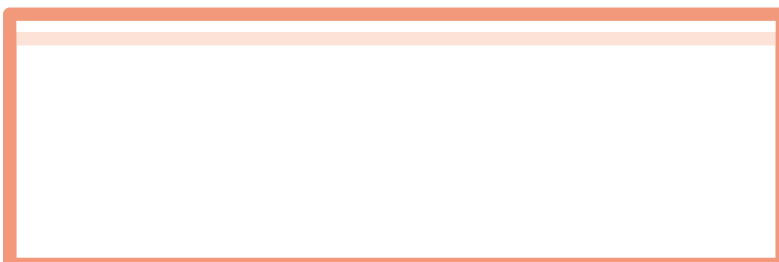

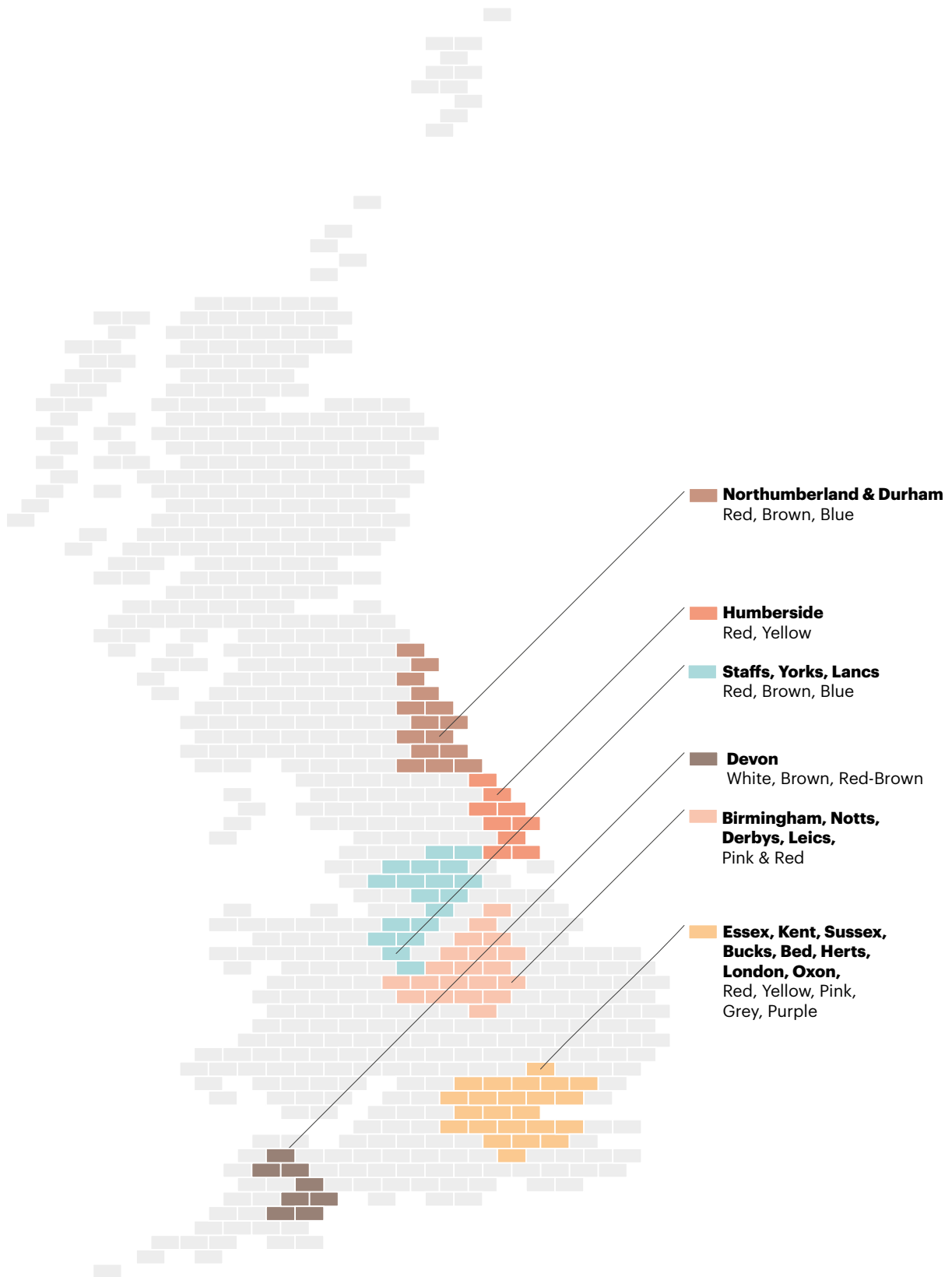

UK Brickworks

The regional distinctiveness of Melton's light pink to deep red brickwork is strikingly different to the yellow 'brick earth' clay deposits found around the south-east, or the 'blood red' clays found in the north. Different clay deposits in the earth vary from region to region and have a great influence on the appearance of the historic environment:

3 historic brick production

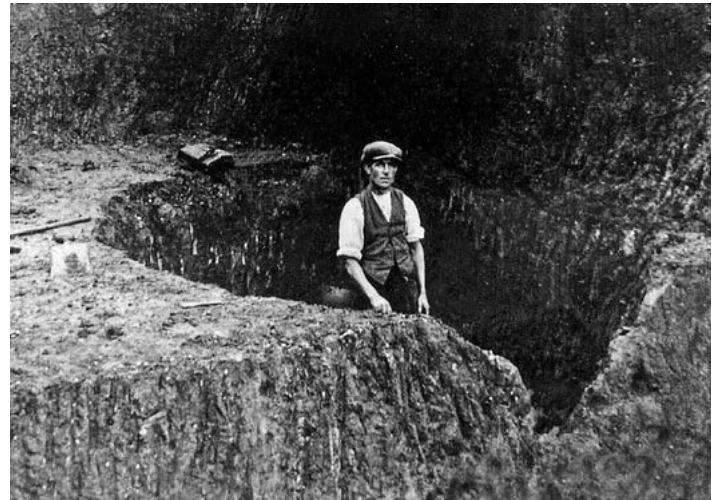

1. production

In 1850, Edward Dobson published a book: 'A rudimentary treatise on the manufacture of bricks and tiles; containing an outline of the principles of brick making'.

Chapter 1 established the 'General principles of the manufacture of bricks and tiles' which he identified as:

1. The preparation of brick-earth
2. Tempering
3. Moulding
4. Drying
5. Firing

These principles of brickwork production have changed throughout history as technology evolved, but fundamentally these basic principles have always remained the same.

"These principles of brickwork production have changed throughout history as technology evolved"

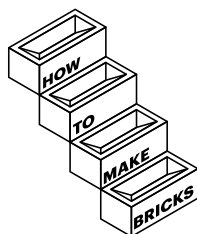



1a. the preparation of brick-earth

Traditionally clay was dug out of the ground manually with spades and the work began in September. Clay pits were mostly shallow and once the required materials had been extracted, the earth would be replaced and the land was once again returned for farming purposes. The excavated clay would be broken down by the weathering process of winter frosts and brickmaking began in April each year.

Before the advent of the canal and railway systems of the industrial revolution, most brick buildings were made from the earth taken from the immediate surroundings. This is why pre-industrial brick architecture is useful when seeking to identify the composition of the clay in a particular area. Although clay extraction is now a mechanized process, many brickyards were still digging up by hand until the early twentieth century.

“The excavated clay would be broken down by winter frosts and brickmaking began in April each year”

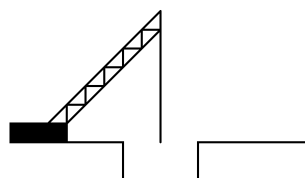

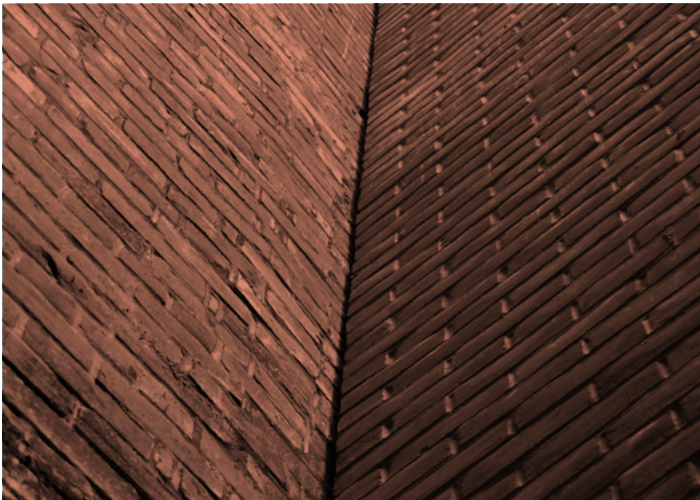

1b. tempering

There first large-scale commercial brick manufacturers were not in production until the nineteenth century. Before this time, many clay pits were dug close to the building site. They were shallow, and there were many impurities in the clay which needed to be removed, before water was added, and the clay compressed to reach the required consistency; a process known as ‘tempering’.

Following the mechanization of the extraction process, it became possible to reach deeper underground and search for clays with less impurities.

It is sometimes (but not always) possible to identify pre-industrial vernacular brickwork for the impurities that survived the tempering process: (show picture of brick with scorch marks). It is very rare to find a pre c19 building with bricks that have a perfectly smooth face.

impurities in the clay which needed to be removed

“Following the mechanization of the extraction process, it became possible to reach deeper underground and search for clays with less impurities”

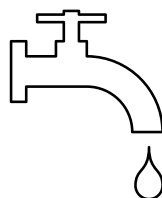



1c. moulding

Since the anglo-saxon period, bricks have been made in moulds, using a box or frame filled with tempered clay. Originally the clay was taken from a pile and shaped in its own timber frame. The hand-made process ensured that no-two bricks were identical and pre-industrial bricks are noticeable for their irregular, uneven surfaces.

From the beginning 18th Century the moulds frequently included an indent, known as a 'frog', and later brickmakers began to imprint their name into the brick.

The industrialization of the moulding process allowed bricks to be 'pressed out' more consistently, the moulds were made from iron or steel and bricks and they could be produced at the same time in large numbers. By the 1860s, bricks were extruded with a tensioned wire which gave them a much more uniform, sharper appearance.

"From the beginning 18th Century the moulds frequently included an indent, known as a "frog"'"

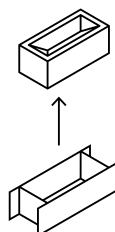

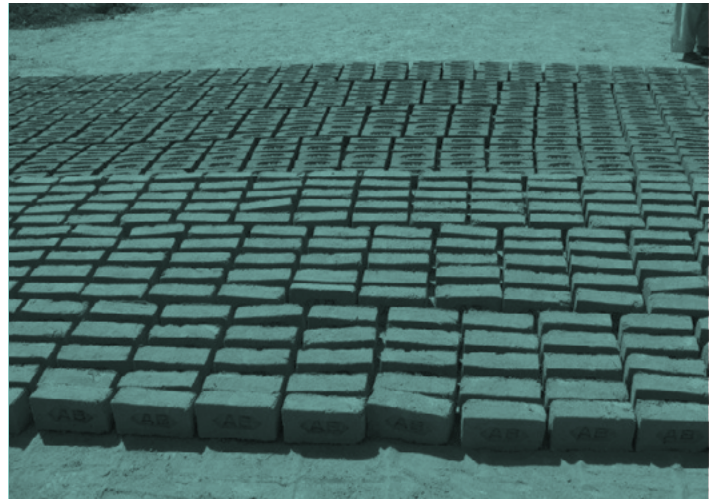

1d. drying

Newly moulded bricks ('green bricks') need to be dried before they can be handled. Traditionally, they were stacked on top of each other 'on end', until they were six or seven courses high.

The process often left characteristic 'pitching marks' on the stretcher faces of the finished bricks. They were left for up to six weeks until they were dry enough to be fired in the clamp or kiln and it was essential to allow water to evaporate slowly to avoid uneven drying.

"The process often left characteristic 'pitching marks' on the stretcher faces of the finished bricks"

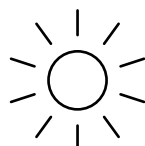

traditional brick clamp

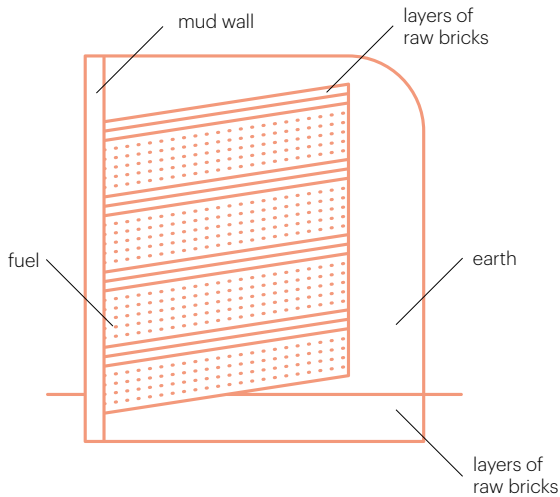

1e. firing

Traditionally handmade bricks were fired to temperatures between 900 and 1100 degrees Celsius. As the temperature rises, the clay particles fuse together, and the process of 'vitrification' (transforming from a liquid to solid) begins.

Maturation is the point at which the fired clay reaches its optimal point of vitrification. The chemical composition of the clay determines the temperature at which maturation takes place, and this adds to the variable quality and appearance of bricks, as it depends on the region in which the clay has been extracted.

Even then, a series of bricks produced from the same clay can have a different chemical composition which contributes to their irregularity. Industrial methods of production have eliminated such chemical imbalances, which allows for a more uniform appearance to modern bricks.

Bricks have been fired in 'clamps' since the middle ages. Clamps are temporary structures made with stacked layers of green bricks, surrounded by earth, with fuel beneath them. The earth acted as a protective casing and once built, the clamp was set on fire and left to burn for several weeks and left to cool for up to a month.

Once a clamp was set on fire, there was no further method of quality control, and it resulted in highly variable finishes. For example, those bricks closest to the wood fire would often become completely vitrified, resulting in a blackened or silver-grey appearance. These 'flared' bricks were then used to make brick patterns, known as 'diapering'.

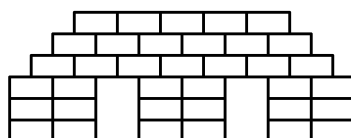

hoffman kiln

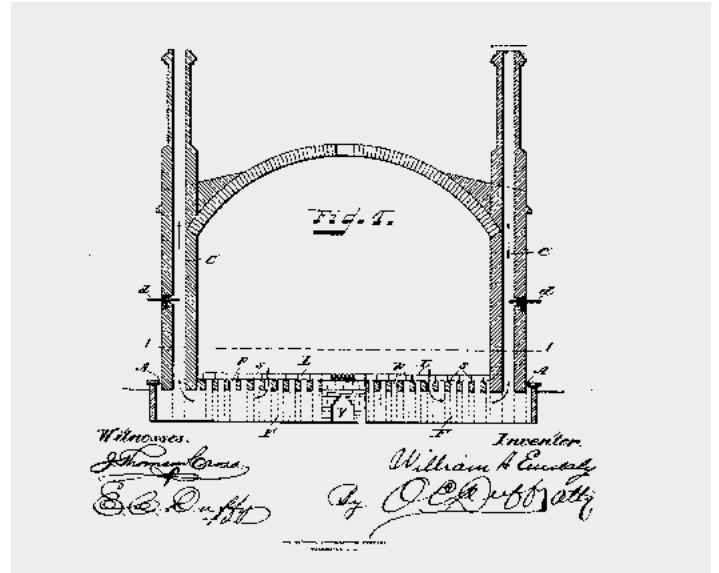
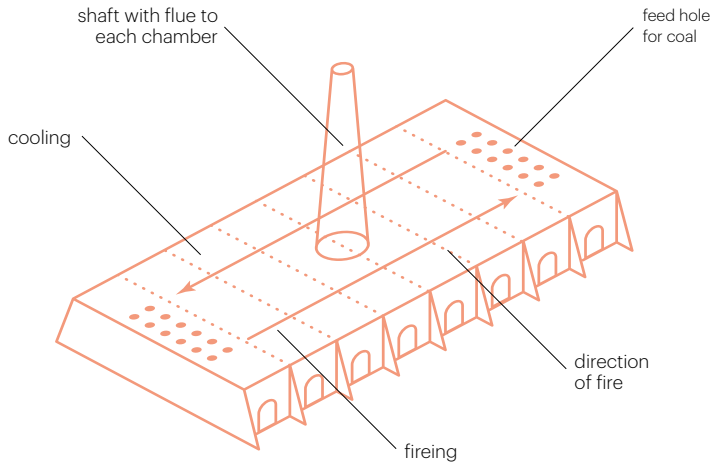

Brickmakers developed their production methods with the introduction of 'updraught' kiln, a permanent structure with openings on each side with an entrance for loading and unloading the bricks. Once the kiln was loaded, the opening was sealed and the kiln was lit. The 'fireholes' on each side of the kiln permitted greater regulation of the firing temperature and there were less over / under fired bricks produced as a result.

From the beginning of the 19th century, 'downdraught kilns' were introduced which allowed for an even more precise regulation of kiln temperatures and increased the range of brick colours that could be produced from certain types of clay. Up to 12,000 bricks could be fired at one time. In 1858, Fredrich Hoffman invented a brick kiln that revolutionized brick production; he designed a circular, multi-chambered kiln that allowed for continuous loading, firing and cooling of bricks; the mass-production of bricks had begun.

In the following decades, the vast network of railways allowed uniform, wirecut bricks to be transported anywhere in the country. By the end of c19, the tradition of handmade brick production, with the distinctive vernacular qualities that varied from region to region, had come to an end.

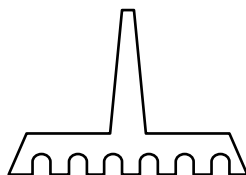



2. historic legislation

2a. the brick tax

On 1st September 1784, at a time of massive exponential growth in brick production, the government introduced a new tax which imposed duties on every 1000 bricks produced. The Government brought the tax in to meet the costs of the American War of Independence and it was a lucrative source of income. The duty was increased in 1794 and again in 1797.

Brick manufacturers tried to reduce their costs by producing larger bricks, but the government outsmarted them by an act of 1803 by charging double duty for bricks exceeding 10" x 5" x 3". The brick taxes coincided with Reverend Parkers 1796 patent for an external cement render ('stucco'), and the fashion for brick facades on high status buildings declined.

“The Government brought the tax in to meet the costs of the American War of Independence”

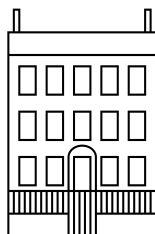

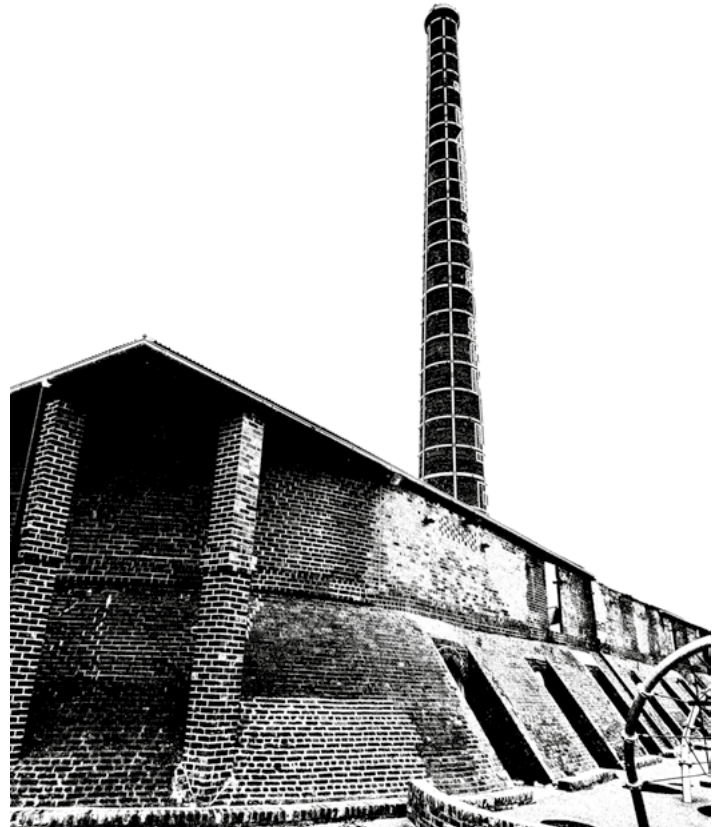

2b. the brick tax repealed

Following increasing industry pressure, the government repealed the unpopular brick tax in 1850. This coincided with the railway construction boom and the advent of the 'Hoffman Kiln'; consequently, millions upon millions of bricks were produced, free from government tariffs, and the legacy of Victorian brickwork can be seen throughout every town in Britain.

“This coincided with the railway construction boom and the advent of the 'Hoffman Kiln'; consequently, millions upon millions of bricks were produced”

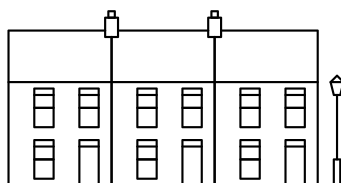

4 brick bonding

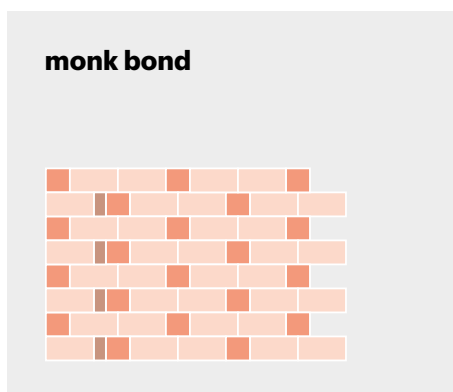
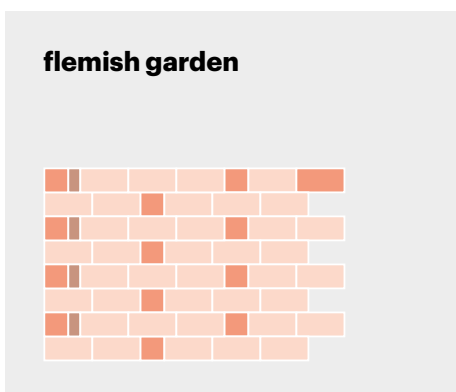
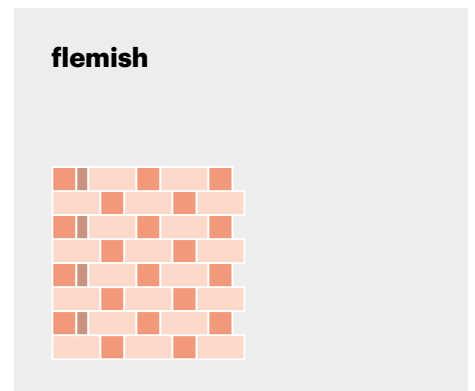
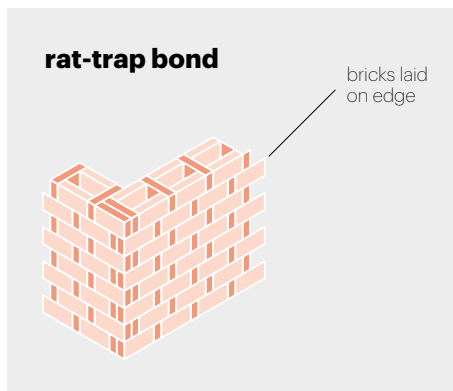
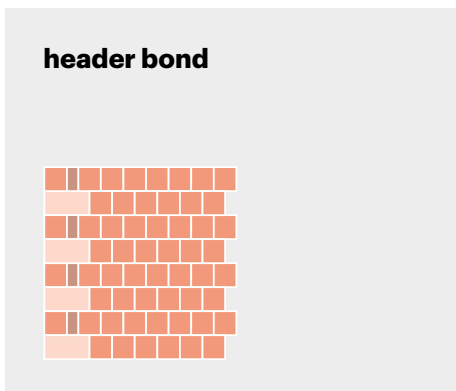
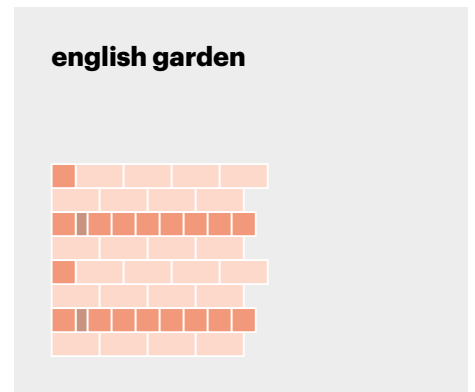
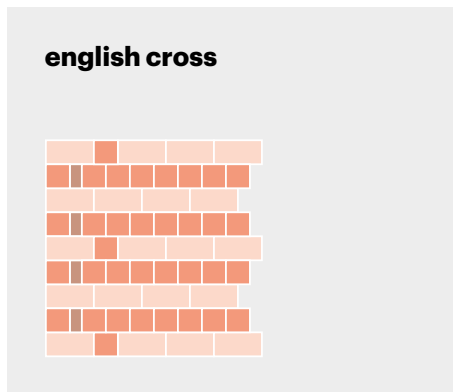
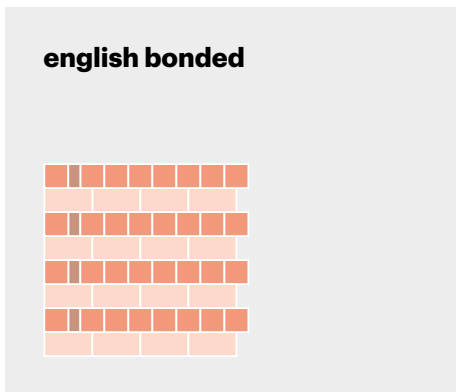
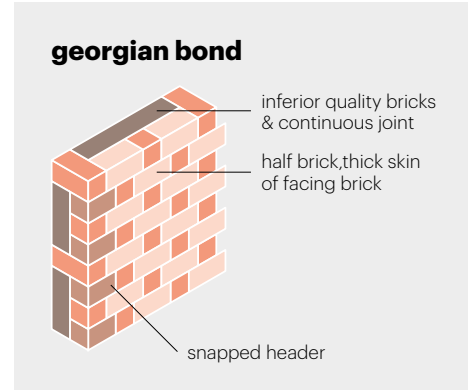
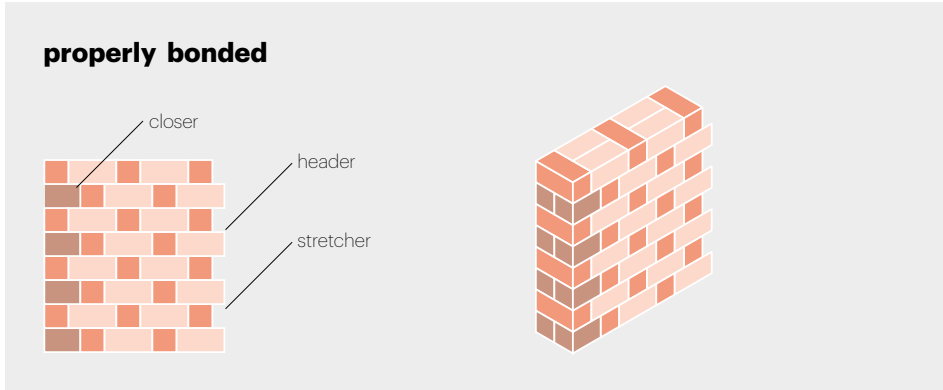

► The many varieties of brick bonds add to the character of historic brickwork, especially in the pattern made by the contrast between the face of the brick ('the stretcher') and the head ('the header').

Unfortunately, since the introduction of cavity walls, brick bonding patterns have largely disappeared, and many brick walls are now constructed in a monotonous 'stretcher bond'.

pointing

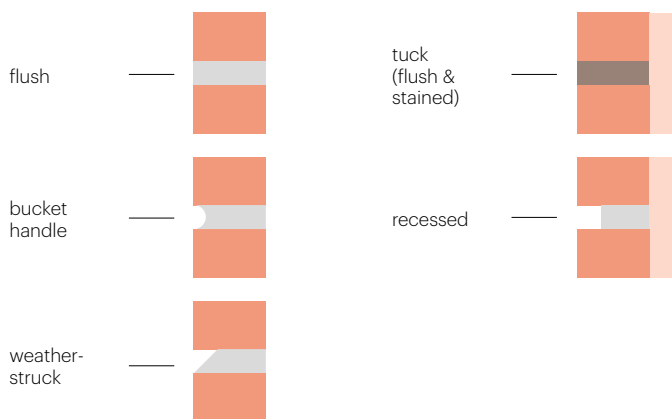

Pointing techniques can also affect the appearance of brickwork. Flush pointing will cover the arris of a brick to achieve a more uniform appearance, while a recessed joint will accentuate any irregularities in texture or dimensions.

Bucket handle pointing is a more conventional contemporary building technique (to allow rain-water run-off) but it is less appropriate in the historic environment. Strap pointing (pointing over the face of the brick) must be avoided at all times and will not be approved on listed buildings.

brick anatomy

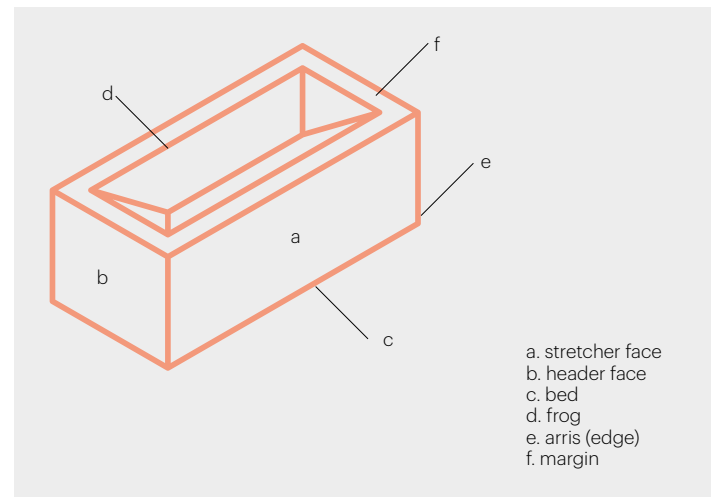

“Flush pointing will cover the arris of a brick to achieve a more uniform appearance, while a recessed joint will accentuate any irregularities in texture or dimensions”

brick construction

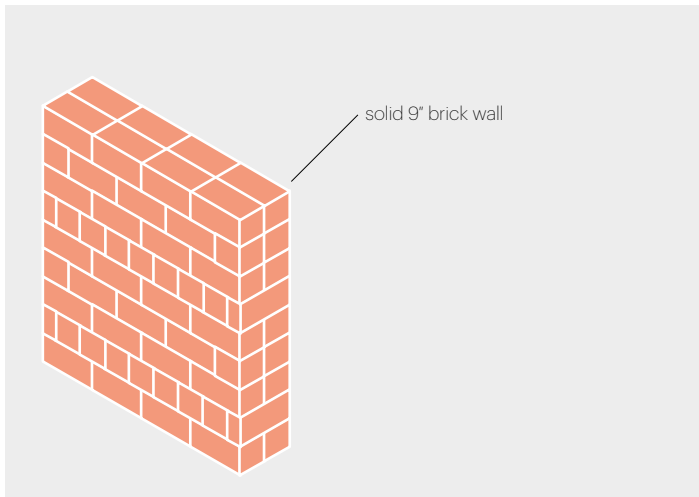

Builders and architects started to experiment with cavity or 'hollow walls' from early in the Victorian period. By the first decade of the 20th century, most pattern books for houses included examples of outer walls with two separate leaves of brickwork.

Initially the development of the 'hollow' or cavity wall was to provide as much protection as possible from the elements, especially driving rain together with enhanced stability and economy of materials. These types of wall first appeared in exposed areas, particularly in coastal locations.

The use of cavity wall construction became increasingly common particularly for the house building boom of the inter-war years where developers saw its economic advantages over solid wall construction. Around 80% of the existing housing in the UK is now estimated to be of cavity wall construction.

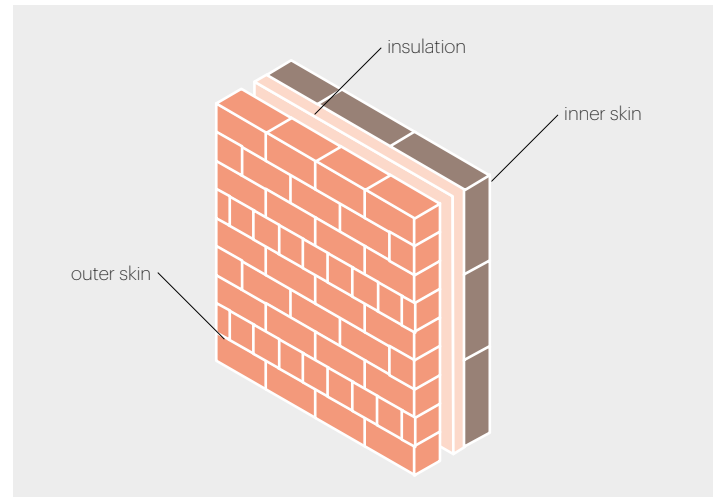

- Most brick buildings built after 1919 look like this, with the outer wall, a single 'skin' of brick, separated from the inner wall by a layer of insulation. Today, the inner wall is commonly built with concrete blocks, which is then covered over by plasterwork.

This is a much cheaper option and brickwork is now mostly used as a facing material for a building because it is durable, weatherproof and timeless.

“Initially the development of the 'hollow' or cavity wall was to provide as much protection as possible from the elements”

5 brickwork revivals



Brick is a building material that has been used since the dawn of civilization. English brick historians such as Lloyd (1925), Brunskill (1970 & 1990) Lynch (1990) and Campbell (2003) have celebrated the many combinations of colours, dimensions, patterns and types of mortar joints to come in and out of fashion.

There were notable 'brickwork revivals' in the Tudor, Georgian, Victorian, Edwardian and Inter-war eras with certain qualities that add to a historic building's special interest.

"There were notable 'brickwork revivals' in the Tudor, Georgian, Victorian, Edwardian and Inter-war eras with certain qualities that add to a historic building's special interest"

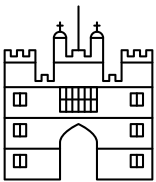

tudor (1485-1600)

English brick historians identify a 'flowering' of English brickwork in the Tudor era. After the Romans left Britain, brickwork went into a long period of decline until the construction of Hampton Court Palace was met with the 'royal seal of approval'.

Historians believe brick returned to fashion because of the shortage of stone, or the emergence of skilled brick makers who were capable of rivaling the country's prestigious stonemasons, or possibly a combination of both factors.

The master craftsmen were responsible for the magnificent elongated and decorative 'twisted chimneys' and 'diapering patterns'; using heavily vitrified bricks to create patterns in a façade:

- ▶ Irregular sized C16 Tudor brickwork which has been badly repointed with cement mortar. The recessed archway is elaborately constructed using specially moulded bricks.
- ▶ The stunning twisted chimneys at Hampton Court which announced the return of brick craftsmanship to Britain C16.

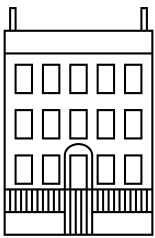

georgian (1714-1831)

The Great Fire of London in 1666 had a huge influence on the next brick revival. Building regulations were steadily introduced which decreed that all buildings had to be built in brick or stone. As stone was expensive where it could not be sourced locally, clamp and kiln technology progressed to meet the new demand for bricks.

Before C18 brickwork only used for high status buildings, but it now became commonplace everywhere, even the lowly laborer's dwelling. The skill of the manufacturing process continued to improve; bricks became more uniform, with accurate color blends and smoother edges.

'Gauged' brickwork (cut and rubbed bricks that have been fired at a lower temperature to allow for precise shaping) rose to prominence, regarded by brick historians as the pinnacle of the bricklayers art.

- ▶ 'Cut and rubbed' brickwork in a Georgian building. The contrast between the rustic, handmade bricks and the smooth, refined 'gauged' brickwork of the window / door heads in this building is particularly striking.
- ▼ An immaculate row of mid C18 Georgian townhouses. The increasing uniformity in brickwork production created the fashion for this 'polite' architectural detail.

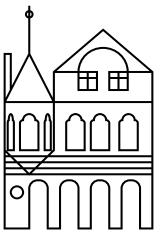

victorian (1837-1901)

The advent of the Hoffman Kiln in the 1860s and the advances in railway technology meant that architects no longer had to rely on local materials. Colour could be introduced into brickwork; the age of 'polychromy' (multi-coloured brick patterned facades) was born.

Suddenly it was possible to combine blue bricks from Staffordshire with yellow stock brick from London, or build with bright Kentish red bricks in a town full of pale stone buildings – all with immaculately uniform wirecut bricks.

Many of the great Victorian 'Gothic-revival' churches were built in polychromy, which set the purists, who believed in monochromatic buildings, against the great reformers who enthused about the importance of colour and patterns in building design.

- ▶ A Watson Fothergill lace warehouse in Nottingham; a superb display of late C19 Staffordshire blue and fireproof red bricks in combination.
- ▶ William Butterfield's Keble College Chapel, Oxford. The polychromy displayed here was an exciting transformation in mid / late C19 church architecture.

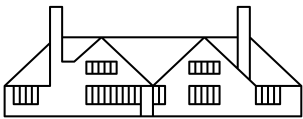

edwardian (1901-1911)

The Edwardian era was the height of the 'arts & crafts' movement, with the revival of traditional construction methods and the use of locally sourced materials.

The great arts & crafts architects; Lutyens, Shaw, Webb and Voysey rejected the mass-produced industrial manufactured bricks, favoring rustic hand-made bricks with their characterful irregularities.

They used wide joints to accentuate the uneven profile of the arris and pale mortar colours that drew more attention to the patterns in the brickwork. The fashion for brickwork had gone full circle!

- ▶ The brick boundary wall and piers at this early C20 arts & crafts house present a total contrast to the immaculate wire-cut brickwork proportions of many mid-C19 buildings.
- ▶ Irregular sized bricks, uneven surfaces and wide mortar joints. The Arts & Crafts movement was a step back in time, evoking an age when bricks were shaped by hand.

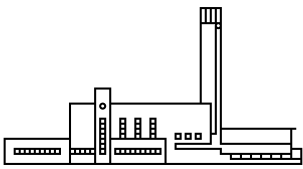

inter-war (1918-1939)

The Dutch modernist movement had a great impact on the construction of brick buildings in the inter-war period. Hilversum Town Hall, designed by Willem Marinus Dudok, used 'thin' bricks (longer and thinner than the standard dimensions) and the design was influential in many 'modernist' buildings built in Britain in this era.

Thin bricks, laid in thick horizontal joints of light mortar, became commonplace on the facades of town halls, theatres, lidos, pavilions and libraries. The brick dimensions were a radical break from the traditions of the past, although the effect on the façade is simple and restrained.

- ▶ 1920s Dutch social housing by the Amsterdam School. The avant-garde Dutch architects used decorative brickwork detailing to great effect in their revolutionary designs.
- ▼ Thin bricks used in the 1931 Hilversum Town Hall contribute towards the building's strong horizontal emphasis. The modernist movement was all about clean lines and geometric proportions.

6 best practice

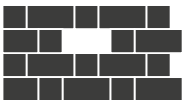

Replacing / Matching bricks

If you need to replace bricks in an existing wall then firstly consider cutting the brick out and turning it around, as the inner 'face' may be preserved in good condition. It is important to ensure there are NO diamond tipped power tools used in the process as they will damage the historic fabric of the building.

If you are looking for bricks to match 'like for like' the existing bricks in your property then try to answer the following questions:

- ✔ Cutting a badly damaged brick out of a wall using an 'Arbotec' drill.
- ✔ Assessing the area to be replaced with a new handmade brick
- ✔ Bedding the new handmade bricks into the wall with lime mortar
- ✔ Applying a brushed finish to the pointing to blend in with the surrounding brickwork

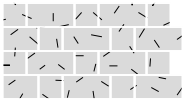
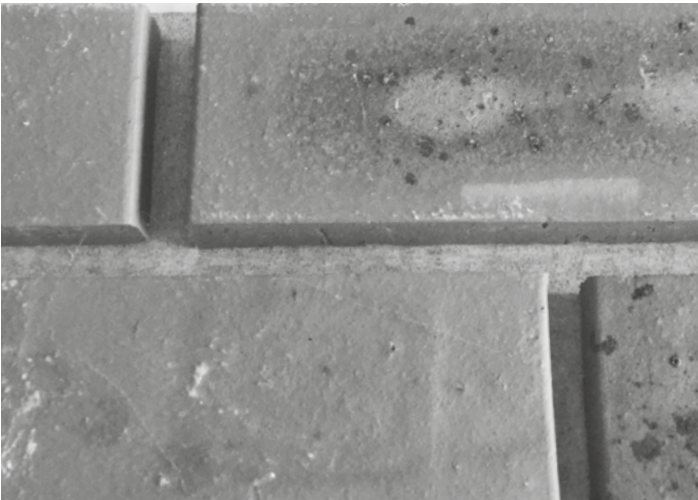

1. Texture

How rough / smooth is the arris of the brick?

Is it a machine-made wirecut brick with sharp, straight lines on the arris, or does it have the rough contours of a rustic handmade brick that was hand pressed into a mould?

Is it too difficult to make such a distinction because the brick arris has been worn down over time?

- A sample panel of a modern machine made wire-cut brick
- The rough, uneven arrises of handmade bricks

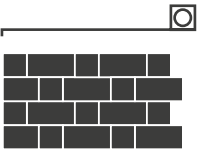

2. Dimensions

What is the length, depth and width of the brick?

Is it a larger Imperial brick, popular in C19, or are the dimensions slightly smaller, possibly pre / post Victorian, and closer in proportion to the metric scale?

Are the bricks 'thin' Tudor style brickwork?

▲ The most noticeable differences between a Victorian 'imperial' brick and a modern day 'metric brick' are the length and thickness dimensions. The differences are subtle but the overall effect on a large elevation is immediately noticeable.



3. Surface

What is the surface finish on the brick face?

Does it have any markings that could have been imprinted during the firing process?

Such as: 'kiss-marks' (because the bricks were marked when they were stacked during firing), a 'brickmakers smile' (which occurred when the clay thrown into the mould box curled upward), bits of stone or grit / impurities that were left in the clay before firing?

Is the face perfectly smooth and unblemished?

Could it be possible that the brick had a smooth finish but the face has 'blown'?

Is the brick glazed?

- ▶ Cut and rubbed ornamental brickwork. The surface of the brick is perfectly smooth and the skill required to achieve such fine joints can only be realised by a master crafts-person using non-hydraulic lime putty.
- ▼ The 'brick makers smile'. A distinctive feature of a hand-made brick which occurred when a mark was left after excess clay was cleared from the top of the mould.

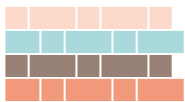

4. Colour

Is the brick a monotone red clay colour?

Or does it have a mottled or speckled appearance with lighter / darker shades?

Is the brick yellow (buff)?

Is it blackened from over-firing or stained by pollution?

Are the bricks a rich variety of contrasting colours?

- Uniform purple mid 20th Century bricks, Het Steiger Church, Rotterdam
- ▼ Yellow brick restoration work on the late 19th Century Arkwright Building, Nottingham Trent University

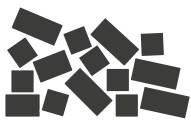
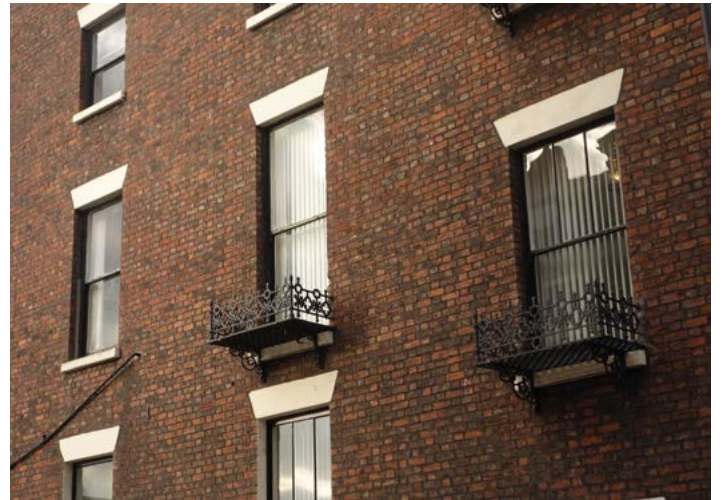

5. Reclaimed Bricks

You may already have reclaimed bricks available from the original historic fabric of your building – these should be the first choice as they a 'like-for like' replacement.

Reclaimed bricks are readily available in builder's merchants or architectural salvage yards. It is crucial to determine the provenance of the reclaimed bricks to match as closely as possible in texture, dimensions, finish and colour.

As a general rule, the older the brick, the more expensive it will be (especially any that predate 'imperials', the most commonly found reclaimed bricks). The Brick Development Association warn that reclaimed bricks require testing to confirm that they are suitable for the purpose intended.

- Bricks that have been crudely pointed awaiting restoration. When the mortar is cleared off the surfaces of the brick it is ready for action.
- A wall rebuilt entirely in reclaimed bricks

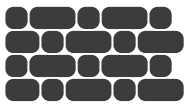

6. Handmade Bricks

If you cannot find suitable reclaimed bricks to match your building then it is possible to source handmade bricks from a company who will provide an almost identical match. There are still artisanal brick manufacturers operating who mix the clay by hand, throw it into moulds and fire the bricks in traditional kilns. This will allow you to match almost identically to the texture, dimensions, face and colour of your original brickwork. Handmade bricks are more expensive than reclaimed bricks but they will have a positive effect on the historic character of your building.

- Replacing a damaged brick in a historic building
- ▼ It is possible to find an almost identical match for historic brickwork

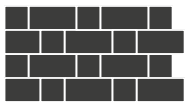
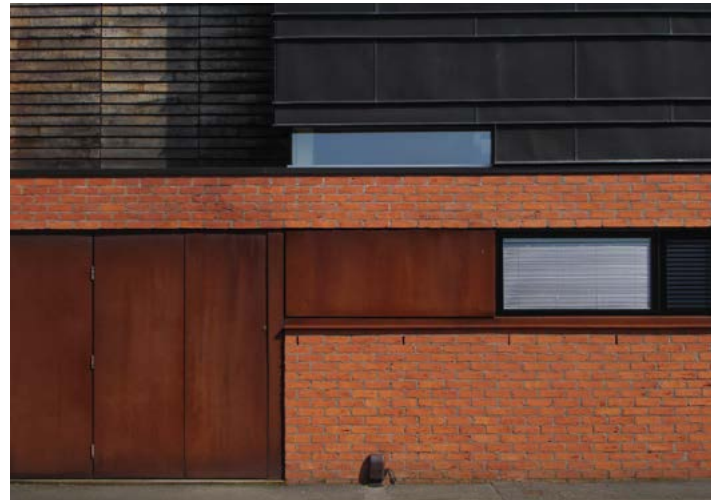
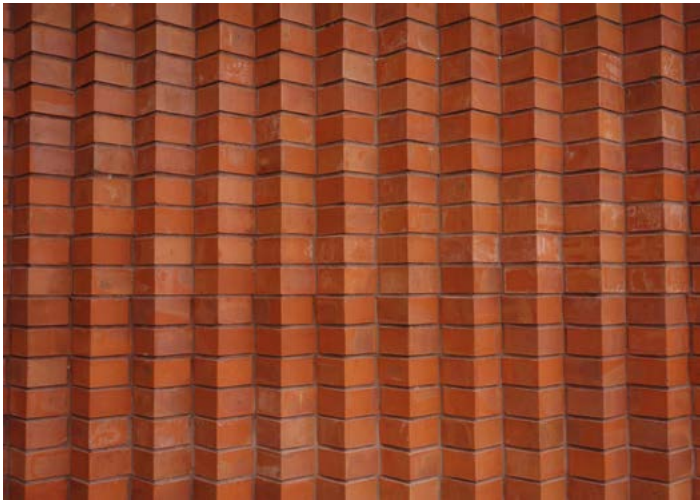

7. Machine made Bricks

If you cannot find suitable reclaimed bricks to match your historic building, or the cost of handmade bricks is outside of your budget, then the alternative option is to source new machine-made 'imitation' historic bricks.

It is important to understand that the use of machine made 'imitation' historic bricks do not count as a 'like-for-like' replacement and they may not be granted permission for use by the Local Authority if your building is listed.

There are thousands of options available, from manufacturers across the globe, who can imitate the texture, dimensions, finish and colour of your brick building, but an 'imitation' historic brick will never be an authentic match.

- ▲ It is still possible to achieve a good outcome using machine made bricks. It's all in the detail (colour / mortar / texture / dimensions).

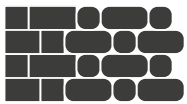

8. New bricks within the setting of a historic building

The application of bricks to an extension of a historic building, or their use in development within the setting of a historic building, requires a well-considered approach that will allow the brickwork to preserve or enhance its surroundings.

Every project will be different and the choice of materials will be determined by the character of the area. In certain circumstances it may be appropriate to use reclaimed, handmade or machine made bricks.

Regardless of the brick specification, there are certain issues that must be taken into consideration and will apply to all new forms of development within a historic environment.

- ▶ New apartments adjacent to the mid C19 Kings Cross Station, London
- ▼ Extension to the late C19 Whitworth Gallery, Manchester

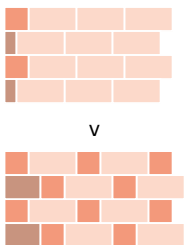

9. Cavity wall construction: Stretcher Bond vs Snapped Headers

After WWI, Building Regulations required all new buildings to include a cavity wall. Therefore modern brickwork is rarely load-bearing and it is only used as an external 'outer' face of a building. It is most economical to use a single skin of brick laid in stretcher bond but the sight of row upon row of brick stretchers, without any headers, can sometimes result in an overly uniform and stark appearance, in comparison to the rich variety of brick bonds employed in a double-skinned brick wall.

As there are very few buildings built before C20 with a cavity wall, a new extension / building in a single-skin stretcher bond may look incongruous in a historic setting. It is possible to resolve this issue by using 'snapped headers' (bricks cut in half and laid in an imitation brick bond). While this practice makes a brick wall appear harmonious with its surroundings, it is not an authentic design because it suggests that the brick is load-bearing when it is not. There is no definitive answer to this question of authenticity and each case must be considered on its own merits.

- ▶ The endlessly repetitive rhythm of stretcher-bond brickwork with modern expansion joints
- ▼ A single skin cavity brickwall. Or is it? Snapped headers have been applied to the brickwork to create the effect of a solid load-bearing masonry wall.

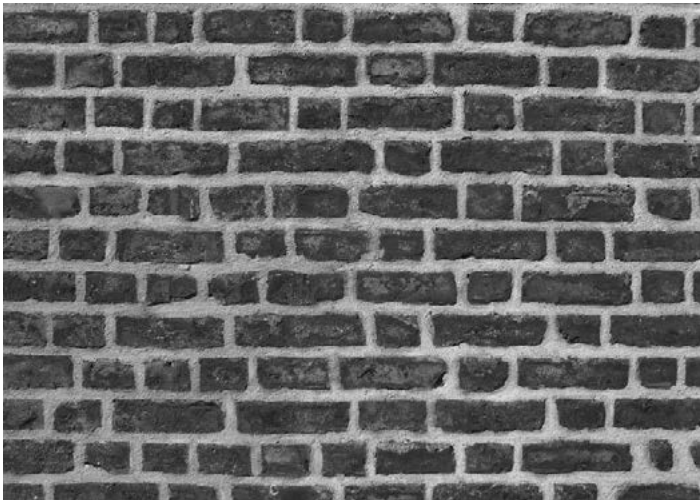

10. Mortar and joint dimensions

The distance between each brick (the joint) can have a significant impact on the overall appearance of brickwork.

A wide joint will emphasise the arris, and can be used to highlight uneven, textured detailing that is commonly associated with rustic handmade bricks and vernacular architecture.

Thin joints will disguise the arris and result in a more refined, uniform appearance that is suggestive of the polite detailing used in Georgian and Victorian high status houses.

A mortar that is lighter than the colour of the bricks will enhance the specification of the brickwork and create a greater contrast between the two materials, as well as emphasising the joints.

Mortar that matches the colour of the bricks will distort the relationship between the two materials, although this may be appropriate were a singular visual mass is required.

- ▶ Modern handmade bricks set in wide brick joints using an NHL 3.5 hydraulic lime mortar.
- ▼ Lovely late C19 terracotta and red brick detailing set in fine mortar joints



11. Brick dimensions and colour

When choosing an appropriate size of brick there are two options: match or contrast with the dimensions and colour of the surrounding historic brickwork.

The decision will have a significant bearing on the distinction between the phasing of the original historic building and the newbuild element.

If you wish to achieve a clean 'break' from the historic building and enhance the distinction between the separate phases, then you may wish to consider using long, slender, Roman / Inter-war style 'thin' bricks, as their 'mellow' profile is strikingly different to the conventional dimensions of many bricks manufactured between 1700-1850. (This was carried out to great effect in the refurbishment of Astley Castle, which won the RIBA Stirling Prize in 2013).

- ✔ RIBA Stirling Prize winning thin bricks contrasting with the historic masonry at Astley Castle in Warwickshire.
- ▼ Reclaimed brickwork used 'like for like' in an extension where it is almost impossible to tell the difference between new and old.

7 glossary of terms*

* The Brick Industry Association (1999)

<u>Arch</u>	A curved compressive structural member, spanning openings or recesses; also built flat.
<u>Ashlar Masonry</u>	Masonry composed of rectangular units of burned clay or shale, or stone, generally larger in size than brick and properly bonded, having sawed, dressed or squared beds, and joints laid in mortar.
<u>Bond</u>	1. Tying various parts of a masonry wall by lapping units one over another or by connecting with metal ties. 2. Patterns formed by exposed faces of units. 3. Adhesion between mortar or grout and masonry units or reinforcement.
<u>Cavity Wall</u>	A wall built of masonry units so arranged as to provide a continuous air space within the wall (with or without insulating material), and in which the inner and outer wythes of the wall are tied together with metal ties.
<u>Clinker Brick</u>	A very hard-burned brick whose shape is distorted or bloated due to nearly complete vitrification.
<u>Corbelling</u>	The use of a series of projecting headers or courses for decorative purpose.
<u>Dentillation</u>	A decorative course in which alternate headers project to give a toothed appearance
<u>Diaper Pattern</u>	A decorative pattern of diagonal intersections or diamond shapes produced by contrasting coloured bricks
<u>Facing Brick</u>	Brick made especially for facing purposes, often treated to produce surface texture. They are made of selected clays, or treated, to produce desired color. See ASTM Specification C 216.
<u>Fire Brick</u>	Brick made of refractory ceramic material which will resist high temperatures.
<u>Gauged Brick</u>	1. Brick which have been ground or otherwise produced to accurate dimensions. 2. A tapered arch brick.
<u>Soft-Mud Brick</u>	Brick produced by molding relatively wet clay (20 to 30 percent moisture). Often a hand process.
<u>Clay</u>	A natural, mineral aggregate consisting essentially of hydrous aluminum silicate; it is plastic when sufficiently wetted, rigid when dried and vitrified when fired to a sufficiently high temperature.
<u>Coping</u>	The material or masonry units forming a cap or finish on top of a wall, pier, pilaster, chimney, etc. It protects masonry below from penetration of water from above.

<u>Corbel</u>	A shelf or ledge formed by projecting successive courses of masonry out from the face of the wall.
<u>Course</u>	One of the continuous horizontal layers of units, bonded with mortar in masonry.
<u>Curtain Wall</u>	An exterior non-loadbearing wall not wholly supported at each story. Such walls may be anchored to columns, spandrel beams, floors or bearing walls, but not necessarily built between structural elements.
<u>Dog's Tooth</u>	Brick laid with their corners projecting from the wall face.
<u>Efflorescence</u>	A powder or stain sometimes found on the surface of masonry, resulting from deposition of water-soluble salts.
<u>Face</u>	1. The exposed surface of a wall or masonry unit. 2. The surface of a unit designed to be exposed in the finished masonry.
<u>Frog</u>	A depression in the bed surface of a brick. Sometimes called a panel.
<u>Header</u>	A masonry unit which overlaps two or more adjacent pieces of masonry to tie them together.
<u>Kiln</u>	A furnace oven or heated enclosure used for burning or firing brick or other clay material.
<u>NHL Lime</u>	Quicklime to which sufficient water has been added to convert the oxides to hydroxides.
<u>Lime Putty</u>	Non-hydraulic lime in plastic form ready for addition to mortar.
<u>Lintel</u>	A beam placed over an opening in a wall.
<u>Masonry</u>	Brick, stone, concrete, etc., or masonry combinations thereof, bonded with mortar.
<u>Mortar</u>	A plastic mixture of cementitious materials, fine aggregate and water.
<u>Pier</u>	An isolated column of masonry.
<u>Pilaster</u>	A wall portion projecting from either or both wall faces and serving as a vertical column and/or beam.
<u>Plinth</u>	Visible projection or recess at the base of a wall.
<u>Quoin</u>	A projecting right angle masonry corner.
<u>Return</u>	Any surface turned back from the face of a principal surface.
<u>Reveal</u>	That portion of a jamb or recess which is visible from the face of a wall.
<u>Shale</u>	Clay which has been subjected to high pressures until it has hardened.

<u>Soffit</u>	The underside of a beam, lintel or arch.
<u>Soldier Course</u>	A stretcher set on end with face showing on the wall surface.
<u>Spalling</u>	A small fragment removed from the face of a masonry unit by a blow or by action of the elements.
<u>Stretcher</u>	A masonry unit laid with its greatest dimension horizontal and its face parallel to the wall face.
<u>Struck joint</u>	Any mortar joint which has been finished with a trowel.
<u>Temper</u>	To moisten and mix clay, plaster or mortar to a proper consistency.
<u>Tooling</u>	Compressing and shaping the face of a mortar joint with a special tool other than a trowel.
<u>Tuck pointing</u>	The filling in with fresh mortar of cut-out or defective mortar joints in masonry.
<u>Vitrification</u>	The condition resulting when kiln temperatures are sufficient to fuse grains and close pores of a clay product, making the mass impervious.
<u>Vousoir</u>	Wedge shaped brick or stone used in a gauged arch.

8 image credits

page	left to right
5	Authors own, Authors own, Authors own, Authors own, Flickr, Creative Commons (Marie 2008), Authors own, Authors own, Authors own, Authors own, Authors own, Authors own, Author design, Authors own, Authors own.
6	Authors own, Authors own
7	Authors own, Flickr Creative Commons (Johnny Hughes 2011)
10	Flickr Creative Commons (Elliot Brown 2010), Flickr Creative Commons (Elliot Brown 2010)
11	Flickr Creative Commons (Christine Frank 2014) Flickr Creative Commons (Karen Blakemen 2012).
12	Authors own, Authors own
13	Flickr Creative Commons (Christine Frank 2014), Flickr Creative Commons (Marie 2008).
14	Flickr Creative Commons (Janelle 2004), Flickr Creative Commons (Janelle 2004)
15	Authors design, Flickr Creative Commons (Sludge G 2012)
16	Authors design, Flickr Creative Commons (Elliot Brown 2010)
17	Authors Own, Wikipedia Commons (Library of Congress)
18	Authors own, Flickr Creative Commons (Pitheadgear 2008)
19	Authors design, Authors design, Authors design, Authors design, Authors design, Authors design, Authors design, Authors design, Authors design, Authors design
20	Authors design, Authors design
21	Authors design, Authors design
22	Flickr Creative Commons (Paul Hudson 2014)
23	Flickr Creative Commons (Paul Hudson 2014), Flickr Creative Commons (Paul Hudson 2014)
24	Authors Own, Authors Own

24	Authors Own, Authors Own
25	Authors Own, Wikipedia Commons (James Park Watt)
26	Authors Own, Authors Own
27	Flickr Creative Commons (Jan Sluitjer 2010), Flickr Creative Commons (Jan Sluitjer 2010)
28	Authors Own, Authors Own
29	Authors Own, Authors Own
30	Authors Own, Authors Own
31	Flickr Creative Commons (Christine Frank 2014), Flickr Creative Commons (Ken McCown 2010)
32	Authors Own, Wikipedia Commons (Daniel Newman)
33	Authors Own, Flickr Creative Commons (Jan Sluitjer 2010)
34	Authors Own, Authors Own
35	Flickr Creative Commons (Stephen Gray 2007), Flickr Creative Commons (Stephen Gray 2007),
36	Flick Creative Commons (Darren Petch 2014), Authors Own
37	Authors Own, Authors Own
38	Authors Own, Authors Own
39	Flick Creative Commons (Mark Sampson 2010), Authors Own

